

Improving the Accuracy of Ultrasound-Based Localisation Systems

Hubert Piontek¹, Matthias Seyffer¹, and Jörg Kaiser²

¹ Universität Ulm

{piontek, matthias.seyffer}@informatik.uni-ulm.de

² Otto-von-Guericke-Universität Magdeburg

kaiser@ivs.cs.uni-magdeburg.de

Abstract. We present an improvement to ultrasound-based indoor location systems like Cricket [1]. By encoding and modulating the ultrasound pulses, we are able to achieve greater accuracy in distance measurements. Besides improving the distance measurements, we improve the position update rate by synchronizing the active beacons. We also propose a method that could further improve the update rate by superimposing encoded ultrasound pulses. Further, an experimental evaluation of our improvements is presented.

1 Introduction

Localisation is still one of the challenges in mobile ubiquitous application scenarios. Because knowledge of the position is the basis for location-based services, navigation and ad-hoc cooperation, considerable research has been expended and many approaches can be found already as working systems and in the literature. However, most of them only allow a rather coarse grained determination of the position. Consider the coordination of autonomous vehicles which use accurate location to coordinate access to junctions or intersections on a factory floor or in a large stock building. It would be highly beneficial if this could be based on an accurate and reliable positioning system. Another example which we aim at is to use robots in a "mixed reality" scenario where they move in a simulated virtual scene and interact with virtual robots. This application requires a very accurate localization of the robots in the real world. Applications like this add a new dimension to techniques of simulating real world settings. We consider in our application mobile robots with a physical size of about 0.4m in length which move with a moderate speed of about 0.7m/sec (see figure 1). From this, we can derive some primary requirements for the location system:

The accuracy of the system must at least be in the order of the size of the robots or better. Our design goal here is a position accuracy of 0.30m. The position update rate must be at least 1/sec. Our robots are capable of moving up to 0.7m/sec. This would correspond to about two robot lengths at full speed. The system must be scalable in space and in the number of clients.

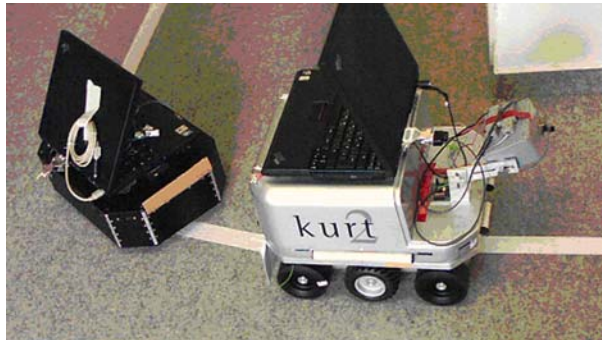

Fig. 1. Cooperating robots

A crucial point in a localization system often is the question of the division of labour between the infrastructure provided in the environment and the respective components on the mobile vehicles. This also affects problems of energy consumption and required computational resources. In a mobile robot, a substantial amount of energy is needed for mobility of vehicles. Compared to this, the energy need for the moderate computational requirements of a location system may be relatively low. However, when considering the infrastructure, it should be simple, easy to deploy and, because it often needs to be operated with a local power source, the energy demand should be low. Thus, we aimed at relatively simple infrastructure composed from simple beacons with low computational requirements and low energy consumption.

The principle of operation is based on distance measurements to at least three beacons and subsequent trilateration. The distance is determined by the differences between the time which a radio signal and an ultrasound signal need to travel from a beacon to the respective receivers on the mobile entity. This is very similar to the principle of the cricket location system [1]. Actually, we first built up the hardware of a cricket system and tried to use it in our mobile environment. However, we discovered two major drawbacks of this system:

1. it was rather difficult to obtain a precise edge of an ultrasound signal. This is mainly because of the limited bandwidth of the ceramic ultrasound transducer. Even when we used a high energy ultrasound pulse, which is not desirable because of energy constraint, the results were not satisfactory. It limits the localization accuracy substantially.
2. the update rate of the cricket system is not sufficient to accommodate high accuracy localization of mobile systems.

The contribution of this paper therefore is to investigate ways of how to improve such a location system. Firstly, we will present and evaluate an impulse compression technique to overcome the first drawback. Then we will describe ways to improve the update rate. The rest of the paper is organized as follows: the next section discusses related work. Section 3 will introduce the general architecture

of the location system and will describe the hardware. It also will briefly address the synchronization of the beacons to avoid collisions on the radio channel. Section 4 will sketch the pulse compression techniques and present results. Section 5 will give a short overview over the activities to improve the update rate of the location system. Finally, we will provide a conclusion.

2 Related Work

There are three basic methods to determine one's location:

1. sensing the location by means of a *sensor grid*: a sensor (e. g. magnetic or pressure sensitive) can detect an object in its close vicinity. Distributing those sensors in a regular grid allows to determine one's position within this grid. The most common example for such a system is a touch screen as found on most PDAs. For our application scenarios of autonomous robots, such (tight) sensor grids would be too costly to deploy. The original Cricket [1], and the Active Badge Location System [10] are of this kind. Both provide location information at the granularity of a room, which does not meet our requirements.
2. sensing the direction of at least two landmarks (of known location) to a common reference (for 2D positioning), and using *triangulation* to determine one's position.
3. sensing the distance to at least three landmarks, and using *trilateration* to determine one's position. A popular example for this method is GPS, which is proven to work reliably at a accuracy down to several meters in an outdoor environment. However, it does not work inside buildings. Laser technology is known for its accuracy, but we considered it to be too expensive, and too complex for our goals. The Cricket Compass [2], Cricket v2 [3], The Bat [8], [9] and RADAR [6], [7] are examples for this type of positioning systems that work indoors. Because we are aiming at a distributed system that is composed of fixed, active beacons and passive mobile clients, The Bat and RADAR are ruled out. The Cricket system comes closest to our goals: it uses easily deployable components. The autonomous system architecture fits nicely into our view of the world where we aim at autonomous components that interact without any central coordination.

RADAR [6], [7] is an RF-based system for locating (and tracking) users inside buildings. It uses the signal strength information from wireless networking equipment. The system is capable of locating users to within a few meters of their actual location. The system uses a combination of empirically determined and theoretically computed signal strength information, as the propagation of RF inside buildings is hard to cope with. One of the advantages of RADAR is, that the means to provide location information also provides traditional data network services. However, the trackable entities are laptop computers. A major drawback is the need for empirical data, which must be collected before the system can go to *real-time mode*, i. e. into operation.

Cricket [1] originally aimed at supporting a user to find his location within one or two square feet. The system architecture is similar to our own: Cricket uses *beacons* that basically advertise their position. *Listeners* that move through instrumented areas use the time of flight of ultrasound signals to estimate the distance to all beacons in (ultrasound) range. The current position is the area advertised by the beacon which is closest to the listener. Cricket's *granularity* is *portions of a room*. As in any other system utilizing both radio and ultrasound signals, corresponding radio and ultrasound signals must be correlated at the receiver. Cricket does not modulate the ultrasound signal, so it needed a different mechanism: Typically, radio signals can be received at much greater distances than ultrasound signals. This ensures, that whenever an ultrasound signal is received, so is the radio signal. Using a small bandwidth radio link, and having long enough radio messages, it is assured that the ultrasound signals arrive while the radio message is still being transmitted. In the absence of interference, this ensures that the correct correlation of radio and ultrasound signal is done. Errors in measurement due to changes in the speed of sound — e. g. due to temperature — are irrelevant because only the closest beacon is used to determine the current position.

The Cricket Compass [2] improves the original Cricket system on the listener side only. Besides mere distance measurement, the receiver orientation towards the beacon is determined. This can be done using five ultra soundreceivers in a V-shape, and measuring phase differences in the incoming ultra sound signal. With Cricket Compass, positioning in terms of absolute coordinates within a room was introduced. This requires at least four beacons. The method described in [2] overcomes the problem of not knowing the speed of sound, so no further sensory equipment is needed.

Cricket v2 [3] is based on improved and simplified hardware components. Cricket hardware units can be configured to either be a beacon or a listener. The API has been extended, and a software distribution allowing to develop Cricket enabled applications e. g. in Java is available.

3 Positioning System

The basis for our location system is distance measurement. A *client* measures the distance to several (3 or more) *beacons*. Taking these distance measurements, it calculates its position using multilateration. Beacons are attached to the ceiling. They are equipped with a radio module and an ultrasound transmitter. Within each room, all beacons should be mounted at the same height (see figure 2a). A client (e. g. on a mobile robot) can determine its position in a three dimensional space by measuring the distance to at least three beacons: Two measurements limit one's position to somewhere on a circle (denoted by the thick vertical black line between the intersections of the two circles in figure 2b). The third measurement reduces this to two points on this circle (The intersection of both circles in figure 2c). One of them can be discarded, as it is above the beacons, which is impossible because of the directional characteristics of the ultrasound transmit-

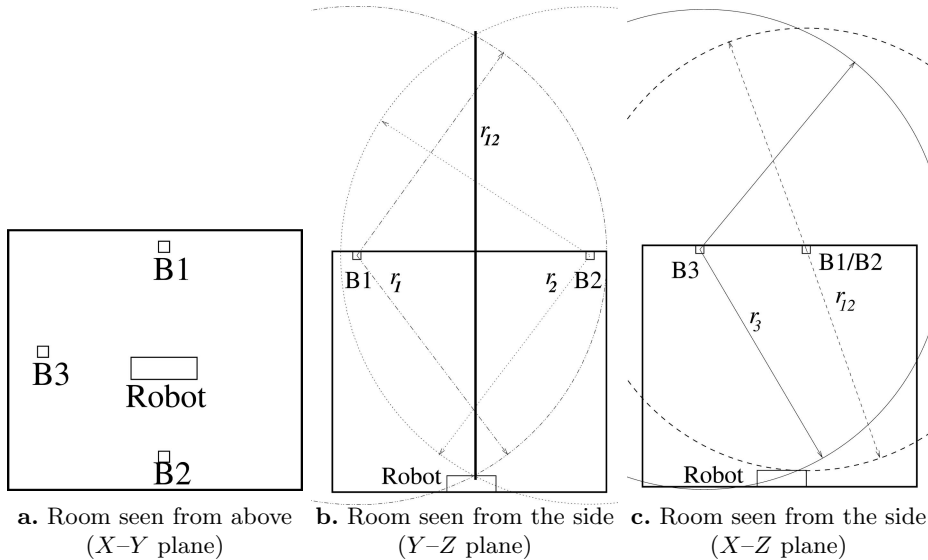

Fig. 2. System Architecture

ters. The measurements ideally should be done simultaneously, especially if the robot is moving.

3.1 Distance Measurement

Distance is measured using the difference in time-of-flight of RF signals and ultrasound signals.

The time difference for travelling a distance d between the ultrasound signal and the radio signal is

$$t = t_{us} - t_{rf} = \frac{d}{v_{ultrasound}} - \frac{d}{v_{radio}}$$

For a distance d of 10m, the radio signal needs about $t_{rf} \approx 30\text{nsec}$. The ultrasound signal, however, will need about $t_{us} \approx 30\text{msec}$. As $t_{rf} \ll t_{us}$, t_{rf} can safely be omitted from the above term.

Unfortunately, the speed of sound is not constant. It varies e. g. with temperature. Between -20°C and 40°C , it can be approximated in a linear fashion: $v_{ultrasound} = (331.6 + 0.6 \cdot T) \text{m/sec}$ where T is in $^\circ\text{C}$. Not dealing with temperature would introduce rather large errors, e. g. 3.4% or 0.34m when measuring a distance of 10m and going from 10°C to 30°C .

There are two possibilities for dealing with unknown speed of sound: (1) try to approximate the speed of sound using sensors, e. g. temperature sensors, and (2) using one more beacon, and introduce it as another unknown variable in the positioning calculations. Of course, the latter assumes, that the speed of sound remains constant within a room for the duration of a positioning operation. This enhancement is based on the work of the Cricket Compass [2].

3.2 Synchronisation of Beacons

The beacons become active in a time-triggered fashion, both for simplicity, and for avoiding collisions (see section 5). The timely properties of the radio channel is well known in our setup, as we use low-power RF modems [11] that show a well-defined behaviour.

3.3 Hardware

Our initial approach was to build a Cricket v1 clone using the same analogue tone decoder for detecting the ultrasound pulse that was originally used with Cricket. The beacons simply sent a constant ultrasound "tone" for a small period of time. The receiver should ideally detect this tone right at the first "edge". In practice, it took the tone decoder several milliseconds for the incoming carrier tone to be detected. With this setup, the distance measurements had errors in the range of several tens of centimeters for perfectly aligned ultrasound transmitters and receivers. When the ultrasound parts were only slightly misaligned, we had even worse readings (see also [5]). We were able to improve the system by discarding the analogue tone decoder. Instead, we fed the amplified input signal to a comparator circuit. The output is a binary signal that was directly fed into a microcontroller's capture unit. Tone detection was done in software [13]. We recently became aware that Cricket changed to the same technique [4], [5]. The results were promising for aligned ultrasound transmitters/receivers: all measurement were within $\pm 2\text{cm}$ of the actual distance. Measurement errors grew with the misalignment of the transceivers. when misaligned by more than 35° , the measurements became completely unreliable. Our current approach is to use pulse compression on the ultrasound channel to get accurate distance measurements. The theoretical background is briefly described in section 4, and in more detail in [12]. The beacons (see figure 3a) use an 8 bit microcontroller [16]. They communicate via radio modules. The modulated ultrasound pulse is created in software, so the hardware is kept as simple as possible. The clients (see figure 3b) are more sophisticated. The incoming ultrasound signal is amplified and fed directly to a low-power DSP (Motorola 56F800, about 30 MIPS). The DSP is in charge of demodulating and correlating the incoming signal. It essentially sends a timestamp to an 8 bit microcontroller (same type as on the beacons) which then does the final calculation of the distance.

4 Pulse Compression

The resolution of distance measurements is directly proportional to the sending of an extremely short pulse (*Dirac-pulse*). Sending a very short, single pulse, however, leads to misdetections, as random noise could be misinterpreted as the expected single pulse. There are two solutions to misdetections: (1) make the pulse a very-high power pulse, so that its signal-noise-ratio is good enough, or (2) generate a longer and weaker pulse with the same amount of energy as the short and very-high power pulse. Due to the limited bandwidth of approx.

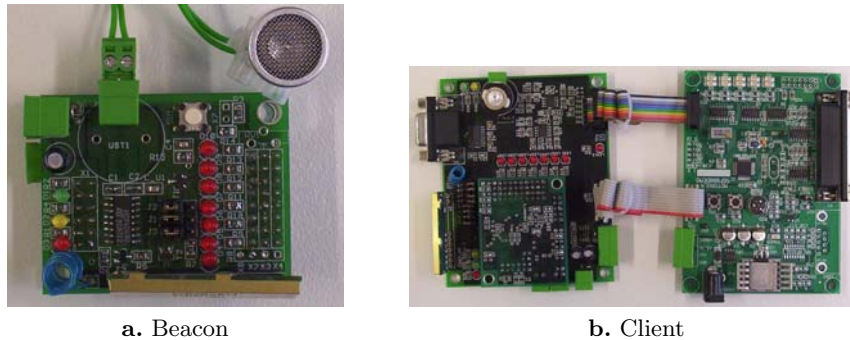
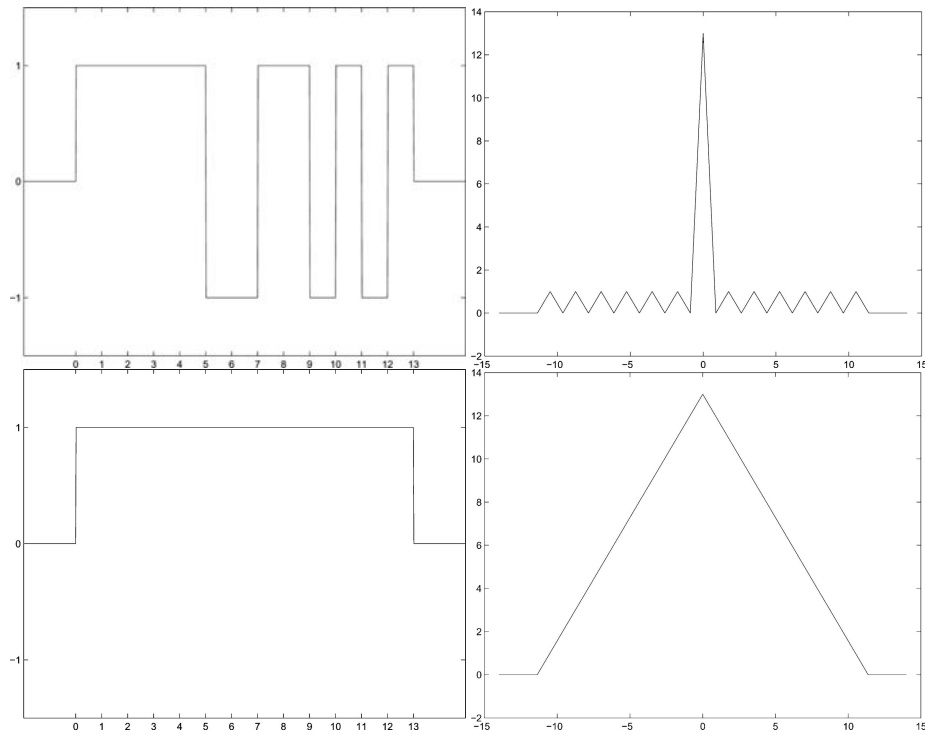

Fig. 3. The components of our location system are equipped with a radio module and an ultrasound transducer

2 – 4kHz of ceramic ultrasound capsules and their voltage limit of about 15V, it is impossible to generate a short pulse with high enough energy. The drawback of the longer and weaker pulse is worse distance resolution, but it can be sent with narrow band devices. To achieve proper distance resolution, the ultrasound signal must be encoded in an appropriate way, called *pulse compression*. The receiver can then apply correlation filters, that transform this long, low-power pulse to a short peak, that gives a similar distance resolution as the short, high-power pulse. To encode the signal several methods can be used. But considering the computational power of our beacons, we had to use a simple method. We encode our signal using binary pseudo-noise sequences (PN sequences). These are modulated using binary phase shift keying (BPSK). BPSK matches the computational abilities of our beacons and achieves a good coding efficiency of 1 bps per Hz of bandwidth. For our ultrasound transducers, this yields a maximum data rate of about 2000Bit/s (as we have a usable bandwidth of about 2kHz). The PN-sequences must have the characteristic to provide a good autocorrelation function to get a sharp peak. Barker-Codes are a class of well-known codes that possess the required correlation properties (see figure 4). The disadvantage of Barker-Codes is the limited maximum code length of 13 Bits. The Barker-Code's auto-correlation exhibits a sharper edge than the "triangle" shape of the ping's auto-correlation. This shows that a ping, as used in our first experiments, is not very suitable to achieve good distance resolution. Demodulation and correlation on the receiver side are done in software on the DSP. For best results the signal must be sampled at a rate of 160kHz. The optimal receiver must correlate the incoming signal with the stored reference signal continuously. Such a receiver would need about 166 MIPS at a bitrate of 2000Bit/sec. We use a modified BPSK-demodulator (see figure 5) to limit the demand for computational power. First, the received signal must be transformed from a pass band signal to a base band signal by the quadrature mixer. The signal is splitted into a in-phase and a quadrature component. Before a data reduction stage, the signals are low-pass filtered. The resulting signals are correlated with the stored Barker-Code using the schema in figure 6. These modifications to the



1 and -1 stand for the two symbols usable with BPSK when transmitting, whereas 0 stands for "transmitter switched off"

Fig. 4. BPSK modulated Barker-Code (top left, 13 bits), and its auto-correlation (top right) vs. Ping (bottom left, 13 bits), and its auto-correlation (bottom right)

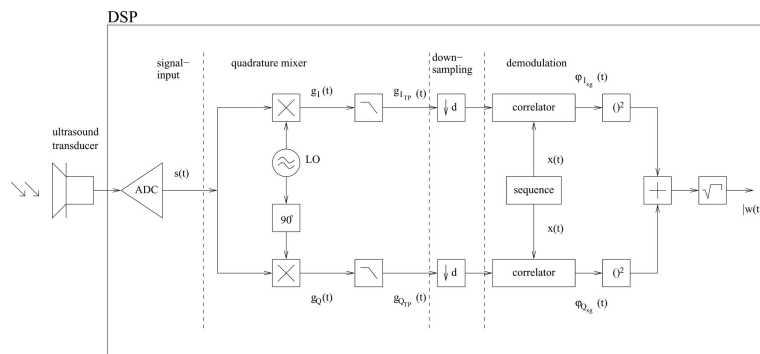

Fig. 5. Demodulation of the incoming signal

BPSK–demodulator reduce the computational requirements to about 10 MIPS. Of course, these modifications degrade accuracy. The overall accuracy we experienced is well within our requirements (see section 4.2). The resulting signal of

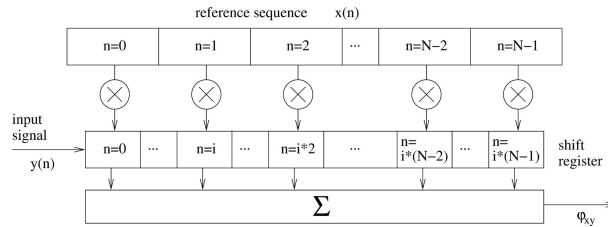

Fig. 6. Correlator

the receiver is an envelope, showing how good the received signal matches the stored signal. The best match and thus the time of arrival of the signal can be easily determined by a search for the global maximum.

4.1 Theoretical Results

Using a sampling rate of 160kHz, a best–case resolution of about 2mm could be expected. Because the signal is phase–coded, the resolution cannot be less than the wavelength of the ultrasound signal, which is about 8.6mm. To achieve this accuracy in practice, very long PN–sequences are needed, which would affect the position update rate. The bitrate of the signal gives an absolute worst–case resolution (upper bound) of 20cm.

4.2 Experimental Results

To get an idea of the behavior in the real world, the test setup in figure 7 was used for first experiments. The data rate was set to approximately 1666Bit/s and the 13 Bit Barker–Code was used. Several measurements were done at distances from 0m to 2m. The sender was mounted below the ceiling 2.13m above the receivers. The first test showed the expected result. It is presented in figure 8a. The upper graph shows the received ultrasound signal. The BPSK encoded Barker–Code is visible starting at a time of about 7msec, corresponding to a distance of 2.35m. An echo is visible at approximately 19msec, corresponding to about 6.5m. The lower graph shows the ”detection envelope” with the global maximum corresponding to the beginning of the incoming waveform, and a local maximum for the weak echo. The second test (figure 8b) shows unexpected behavior. The signal is superimposed by several reflections and echoes. In the lower graph, it can clearly be seen (by a human observer) that the beginning of the signal was correctly detected at approximately 6msec, or 2.13m (the first major peak of the detection envelope). However, the global maximum results from a reflection. This is possible because of the direction dependant attenuation characteristics of the ultrasound transducers. This problem shows that a search for the global

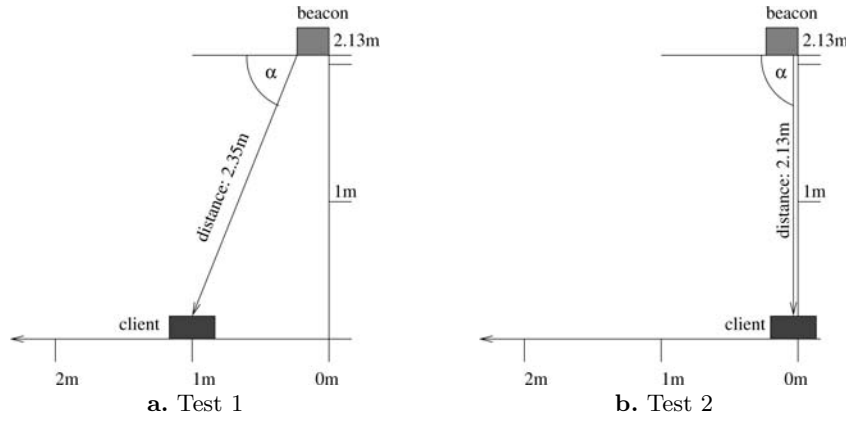

Fig. 7. Test setup

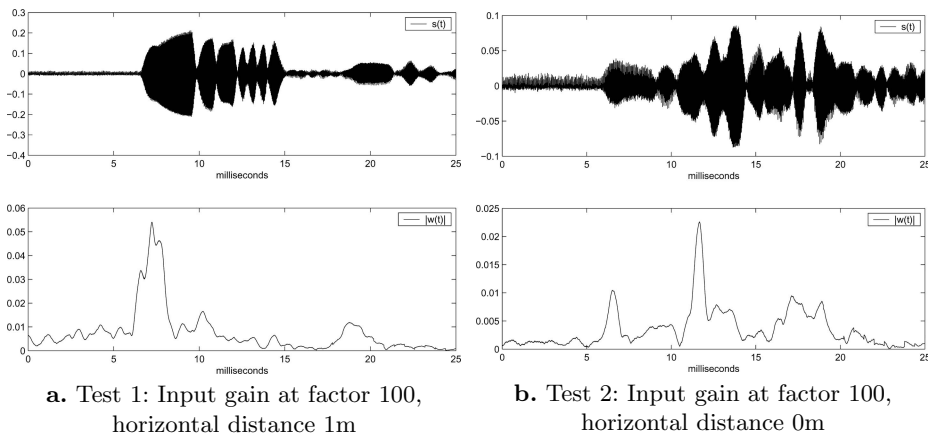

Fig. 8. Test results

maximum cannot be used in practice. We are working on a heuristic method to find the first peak in the envelope. Leaving out these misdetections, the overall accuracy of the system is within 10cm. This may not look like an improvement over the comparator based approach, however the error bound of 10cm holds for all correctly detected ultrasound pulses. Misaligned transceivers do not lead to growing errors in distance measurements.

5 Improving the Position Update Rate

The most obvious way to improve the position update rate compared to Cricket is, to synchronize the beacons among each other. We chose a simple TDMA scheme combined with the separation of larger areas into cells [12]. Inside a cell,

a beacon is assigned to a single time slot. All time slots have the same predefined length. The beacons listen to the radio channel to synchronize to the beginnings of the time slots and to send the ultrasonic pulse within his assigned time slot. This avoids collisions on the radio channel, as well as collisions on the ultrasound channel. Using a bitrate of 2000Bits/sec and the 13 Bit Barker-Code, the ultrasound pulse has a duration of 6.5msec. Within 60msec this pulse can travel about 20m. After this distance, it is not detectable anymore. That means that we are able to do one distance measurement in 66.5msec, or 15 measurements per second. Because we need three measurements to calculate a position, we can achieve a position update rate of 5Hz.

To further improve the position update rate, tests with multiple beacons sending simultaneously were done. Each beacon uses a different PN-Sequence. Because there exists only one Barker-Code for any given code length, we used sequences from the group of *Gold-Sequences*. Due to the limited data rate only short sequences in the range of 8 to 16 Bit can be used. Our experiments show that these sequences were too short to separate the incoming signals. To achieve a high enough probability to successfully separate the sequences, the minimum sequence length is 256 Bits [14], [15].

Using such code length results in the need of significantly more computational power and memory for decoding. Sending 256 Bits at a bitrate of 2000Bits/sec takes 128msec compared to 6.5msec for sending a 13 Bit Barker-Code. This method seems to be usable only for ultrasound transducers with a higher bandwidth, and therefore higher possible bitrate. Subsequently sending a 13 Bit Barker-Code and waiting several milliseconds for it to fade away yields an update rate that is comparable to the method of simultaneously sending long codes. The increased effort in decoding simultaneously sent ultrasound signals does not achieve enough improvement to justify itself.

As there are limits to the achievable position update rate, work must be done to extrapolate the position from previous measurements and fuse this information with other sources of location "hints" like odometry, acceleration sensors, or gyros. We believe that this will provide a reliable and up-to-date source of location information.

6 Conclusion

In this paper we discussed the problems of a high accuracy localization system based on distance measurements which exploit the differences in the travel times of ultrasound and radio waves. We showed some intrinsic problems of ultrasound which mainly result from the low bandwidth of the transducers and introduced pulse compression techniques to obtain a sufficiently accurate signal detection, crucial for the accuracy of the distance measurement. Secondly, we briefly discussed the problem of improving the position update rate by coordinating beacons and by using orthogonal sequences that allow the ultrasound signals to be sent completely concurrently. The second method turned out to be feasible only with a high computational overhead and also, because the length of the sequences, the benefits are questionable.

References

1. B. PRIYANTHA, A. CHAKRABORTY, H. BALAKRISHNAN: *The Cricket Location-Support system*, Proc. 6th ACM MOBICOM, Boston, MA, August 2000
2. B. PRIYANTHA, A. MIU, H. BALAKRISHNAN, S. TELLER: *The Cricket Compass for Context-Aware Mobile Applications*, Proc. 7th ACM MOBICOM, Rome, Italy, July 2001.
3. Cricket Project: *Cricket v2 User Manual*, MIT Computer Science and Artificial Intelligence Lab, Cambridge, MA 02139, July 2004, <http://cricket.csail.mit.edu/v2man.html>
4. Cricket Project: *Schematics of a Cricket Mote*, MIT Computer Science and Artificial Intelligence Lab, Cambridge, MA 02139, <http://cricket.csail.mit.edu/software2.0/Cricket.Mote.Schematic.6310-0335-02.b.pdf>
5. H. BALAKRISHNAN, R. BALIGA, D. CURTIS, M. GORACZKO, A. MIU, B. PRIYANTHA, A. SMITH, K. STEELE, S. TELLER, K. WANG: *Lessons from Developing and Deploying the Cricket Indoor Location System*, MIT Computer Science and Artificial Intelligence Lab, November 2003
6. P. BAHL AND V. N. PADMANABHAN: *RADAR: An In-Building RF-based User Location and Tracking System*, Proceedings of the IEEE Infocom 2000, Tel-Aviv, Israel, vol. 2, Mar. 2000, pp. 775–784
7. P. BAHL, A. BALACHANDRAN, V. N. PADMANABHAN: *Enhancements to the RADAR User Location and Tracking System*, Microsoft Research Technical Report, February 2000
8. M. ADDLESEE, R. CURWEN, S. HODGES, J. NEWMAN, P. STEGGLES, A. WARD, A. HOPPER: *Implementing a Sentient Computing System*, IEEE Computer Magazine, Vol. 34, No. 8, August 2001, pp. 50-56.
9. A. HARTER, A. HOPPER, P. STEGGLES, A. WARD, P. WEBSTER: *The Anatomy of a Context-Aware Application*, Proceedings of the Fifth Annual ACM/IEEE International Conference on Mobile Computing and Networking, MOBICOM'99, Seattle, Washington, USA, August 1999, pp. 59-68.
10. R. WANT, A. HOPPER, V. FALCAO, J. GIBBONS: *The Active Badge Location System*, Olivetti Research Ltd, 24a Trumpington Street, Cambridge, England
11. LPRS Data Sheet *Easy-Radio ER400TRS*, available at <http://www.lprs.co.uk>
12. M. SEYFFER: *Lokalisation in Gebäuden mit intelligenten Sensoren*, Diplomarbeit, Universität Ulm, February 2004
13. K. UHL: *In-House Lokalisierungssystem zur Positionsbestimmung von Robotern*, Lab Report, Universität Ulm, May 2003
14. H. D. LÜKE: *Korrelationssignale, Korrelationsfolgen und Korrelationsarrays in Nachrichten- und Informationstechnik, Messtechnik und Optik*, Springer, 1992
15. M. I. SKOLNIK: *Radar Handbook*, McGraw-Hill, New York, 2nd. ed., 1990
16. H. PIONTEK: *Introduction to the Tiny-Board*, Universität Ulm, 2003